

REFINED, RIGHT DOWN TO THE LAST NUT AND BOLT

The compact telehandlers 1445/2205/2706



KRAMER
on the safe side



Telehandlers for the professional construction industry

Available at your Kramer distributor

With their particularly compact dimensions, Kramer telehandlers open up a wide range of applications within the construction industry, horticulture and landscaping, municipalities and rental parks. Stacking and transport work is fast and easy in even the tightest of spaces. These efficient machines impress with their dynamic all-wheel drive, high payload, unbeatable manoeuvrability and low weight.



On the safe side with Kramer

Rich in tradition, the Kramer brand has been established on the market for many years and in particular stands for one value: **Safety**. The high quality of the innovative machines is only one aspect of this. Kramer is also a safe choice as a company for customers and dealers because its experience and innovations ensure secure investments and security for the future. In short – you are always on the safe side with Kramer: **“Kramer – on the safe side!”**

➔ **ON THE SAFE SIDE**

Table of contents

Kramer telehandlers

Benefits at a glance

04

Telehandler features

Smart Handling
Work hydraulics
Rear tool attachment area

10

Engines

Overview
Exhaust emission after-treatment systems
Performance curves

14

Machine highlights 1445

Electronic drive system
Cabin design

16

Machine highlights 2205

Cabin design
Telescopic arm

22

Machine highlights 2706

Cabin design
Smart Loading

28

Machine components and accessories

Attachments
Quickhitch system
Tyres

34

Technical Data and Dimensions

40

Operating and power ratings for TELEHANDLERS

	1445	2205	2706
Engine output (optional) [kW]	18.4 (33.3)	45.0	55.4
Stacking height [mm]	4,301	5,165	5,730
Payload on pallet forks S=1.25 [kg]	1,450	2,200	2,700
Operating weight [kg]*	3,050 - 3,350	4,200 - 5,000	4,200 - 5,000

* Weight in standard components with full tank + standard bucket + 75 kg operator weight (ISO 6016).

Telehandler with wheel loader properties

Ideally equipped for the construction industry

From the start, the toughest applications were the measure of all things in the development of Kramer telehandlers. The machines were consistently designed for robustness and reliability based on the know-how from the wheel loader development. This can be seen, for example, in the sturdy vehicle frame, which can safely accommodate the payloads of the machine, thanks to its closed design and large material thicknesses.



Flexibility in application

Raise your standards in all areas

With the Kramer telehandlers, you can handle daily work without any problems. The machines not only support you with their impressive performance, but also with standard driver assistance systems and the comfortable cabin designed for maximum ergonomics.



Remarkably compact

The compact telehandlers are characterised by their unique combination of high payload, great lift height, low application weight and a perfect interplay of powerful engine output. With the all wheel steering and the ultra-compact dimensions, the efficient machines ensure unbeatable manoeuvrability. Stacking and transport work is quick and easy in even the tightest of spaces. The low overall height makes work, for example in underground car parks, no problem at all.



Impressively versatile

The Kramer telehandlers are the perfect helpers, whether stacking or loading material, every job is done quickly with our powerful all-rounders and a large selection of attachments. The telehandlers can also be supplemented with a wide range of additional options. As a result, the machines can be adapted to your requirements and provide maximum versatility.



Impressively sturdy

You can rely on the telehandlers in terms of their robustness and durability. The load stabiliser for the telescopic arm provides a decisive contribution here. The lifting, tilting and telescopic cylinders are equipped with end damping to absorb pressure peaks in the hydraulic system and/or a swaying of the machine. In addition, no torsion forces affect the centrally positioned telescopic boom on the frame. Operator and machine are optimally protected from shocks.

Flexibility in use

The right steering type for each and every application

The three steering types: all-wheel, front wheel and crab steering are also available for the compact telehandlers, from the 1445 through to the 2706, for maximum flexibility in the most diverse application. No matter whether manoeuvring in the smallest space, driving at speed on the road or guiding special attachments, the appropriate steering type can be selected for each and every application.



All-wheel steering

- 2 x 38 degree steering angle on the front and rear axle ensure quick work processes
- Optimised routes
- Tight turning circle



Front wheel steering

- Safe and familiar road travel at high speed
- Easy guidance of special attachments
- Familiar steering system
- Ideal for trailer operation



Crab steering

- Manoeuvrability in the smallest space
- Precise positioning in the tightest conditions
- Ground protection for sensitive subbase
- Easily move away from walls and trenches



All-wheel steering: particularly manoeuvrable in tight spaces

Ultra-compact dimensions ensure unbeatable manoeuvrability

360° turning manoeuvres

The 1445 telehandler is extremely manoeuvrable with a turning radius of just 2,695 mm. It achieves this high level of manoeuvrability, above all due to its great steering angle of 38° on the front and rear axle, in combination with the compact machine design. As a result, optimised routes and, above all, fast work cycles are now also possible in very tight spaces.

■ Turning circle outer edge tyres

■ Turning circle outer edge attachment

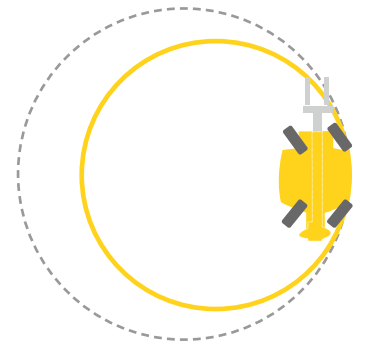

Compact dimensions and optimal power to weight ratio

Power in a perfect proportion

The compact telehandlers by Kramer are versatile and powerful machines for the highest demands and flexible applications in the construction industry. The machine are supremely equipped for demanding and precise work in tight spaces as a result of their design and small dimensions. The compact models are characterised by increased comfort due to their driver assistance system, a wide range of options, as well as a large selection of attachments. The optimal relationship between the application weight and the payload ensures an unaffected viability and efficiency of the Kramer telehandlers.



Compact dimensions: Suitable for tight spaces

Top performance of the dimensions and power to weight ratio:

- perfect ratio between payload and operating weight
- unmatched economy and efficiency
- compact dimensions in the 2x2 metre class



Low overall height of less than 2 m for versatile applications

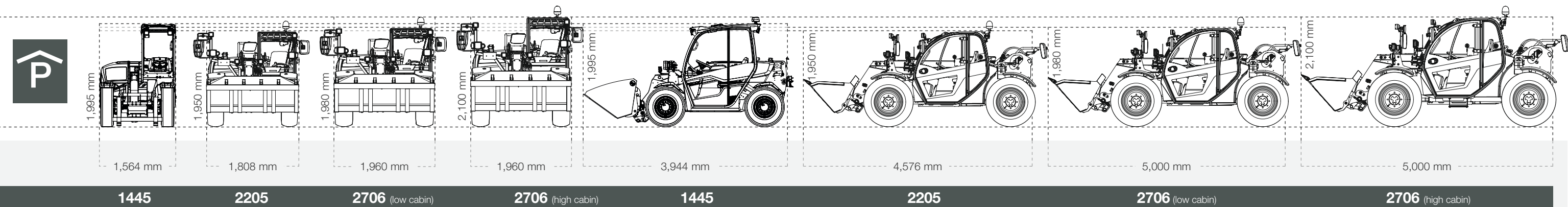

Smart Handling - driver assistance system

Everything under control, even in the limit range

Maximum payload, fully extended loader unit system, engine speed at the detent – the Smart Handling overload protection system always has everything under control in any situation. On the one hand, the intelligent driver assistance system prevents loads from reaching the overload area and therefore threatening to overturn the machine in the longitudinal direction. On the other hand, it takes many routine tasks, such as extension and retraction of the telescopic arm, away from the operator so that he can focus on the essential aspects of his work.



The three functional modes explained

Bucket mode



When lowering the loader unit, the telescopic arm is automatically retracted. This keeps the load as close to the vehicle as possible and it does not create critical situations, even with maximum payloads. The bucket mode is ideal for loading bulk materials.

1445 / 2205 / 2706

Stacking mode



When lifting and lowering the loader unit, the attachment is moved up and down in a vertical line, i.e. the telescopic arm automatically moves in and out and the load is moved up or down in a straight line. Thus, the cargo always remains in the safe range and stacking work at high altitudes is simplified.

1445 / 2205 / 2706

Smart Handling - simply select

The mode can be switched via the selector switch. To temporarily bypass the overload system, the left push-button must be pressed continuously.

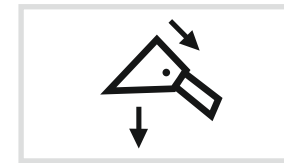

Bucket mode

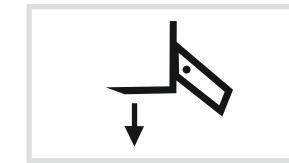

Stacking mode



Manual mode

Manual mode



In manual mode, the machine does not perform any automatic movements of the loader unit. The overload protection is of course still active and stops the loader unit as soon as the overload limit is reached. At this point, only retracting, lifting the loader unit and dumping out the attachment are possible. Due to its class, only the 2706 has this additional technical refinement.

2706

Joystick handling



You have the whole machine under control with the ergonomic joystick. With up to 17 functions, the most important tasks can be done without letting go of the joystick or changing your grip. The joystick is fixed to the console on the right-hand side of the cab.

Powerful hydraulics

For sensitively controlling the machine

Connect and disconnect different attachments, sensitive control, quick working cycles and all of this with a low noise level in the cab: The technology behind the work hydraulics makes this possible.

The work hydraulics are powered by powerful gear pumps, which ensure quick working cycles of the loader unit and allow for the operation of special attachments via the 3rd control circuit, if necessary with continuous function.

Pressure release of 3rd control circuit:
Easily couple and uncouple attachments with hydraulic additional function

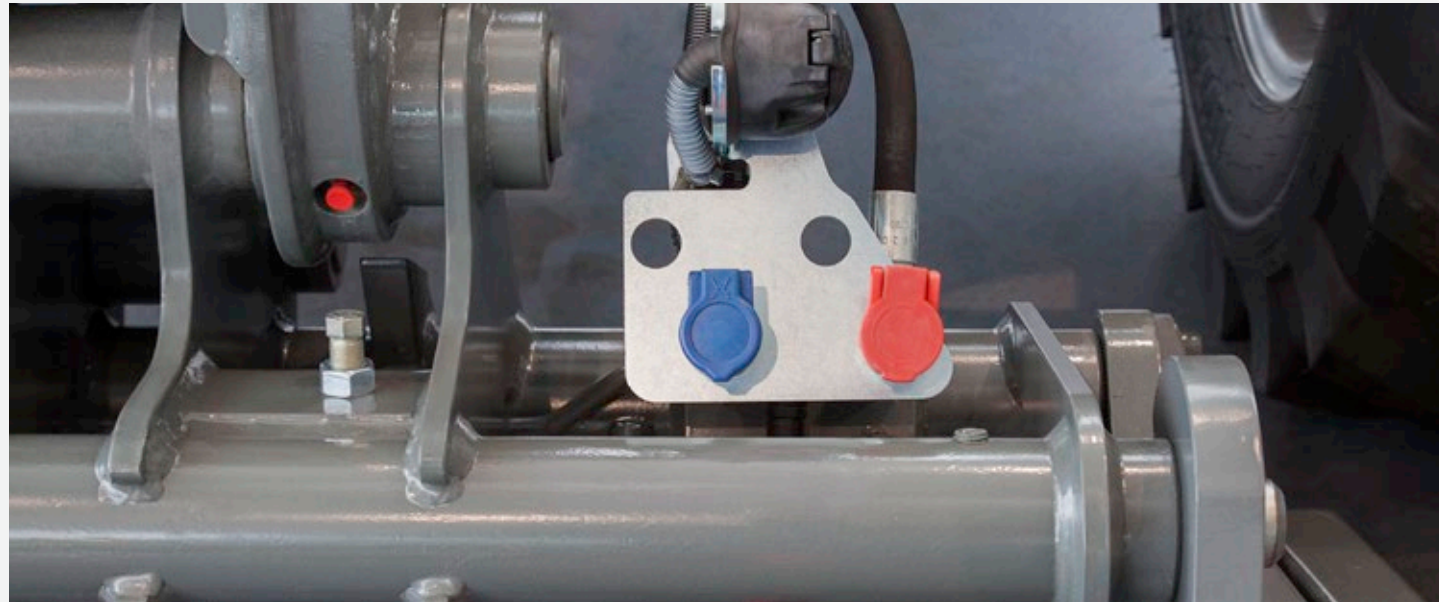

Powerflow

The optionally available Powerflow high-performance hydraulics have been developed especially for demanding applications and special attachments with a constant and high oil requirement, like, for example, snow blowers or mulching devices.

The attachment supply is via a separate pressure line and a depressurised return directly connected to the hydraulic oil tank ensures a high usable power, without unnecessarily warming the oil.



Concept solution for system bearer	1445	2205	2706
Work hydraulics [l/min]*	36.4 (standard) / 42 (option)	70	89
Power flow performance hydraulics [l/min]*	70	100	-

* Values for the engine's rated rpm

- not available

Multi-functional rear attachment area

Maximum versatility for all tasks

The Kramer telehandlers are not only characterised by the various quickhitch systems and numerous hydraulic options in the front. The telehandler's rear attachment area also fulfils all of the important requirements.

Depending on the model, there are various attachment couplings available for the attachment operation. For the 2706, a hydraulic attachment brake system is also available for large attachment loads. Hydraulic auxiliary control circuits are available at the rear for all models, for example for the use of a tipper. For maximum flexibility, the 2205 and 2706 can be optionally equipped with a three-point lifting gear and a rear PTO.

External operating elements (2205 / 2706)
for the rear power lift and the PTO shaft.

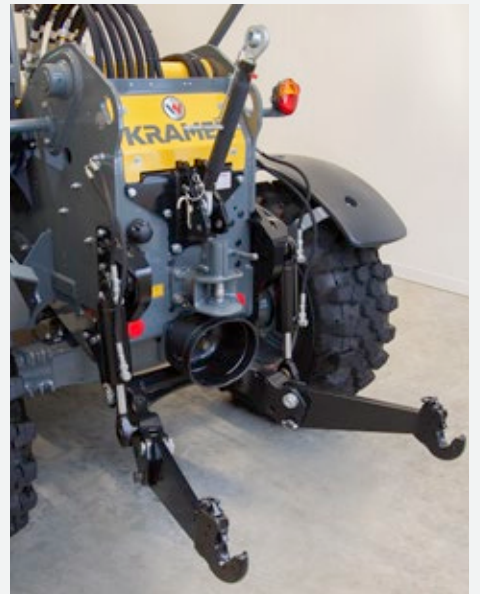
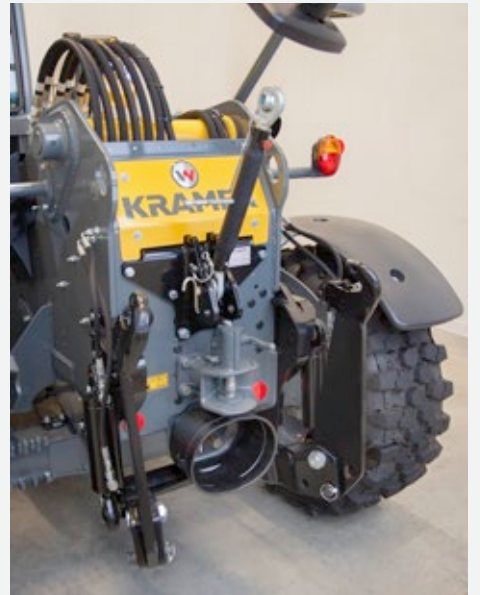
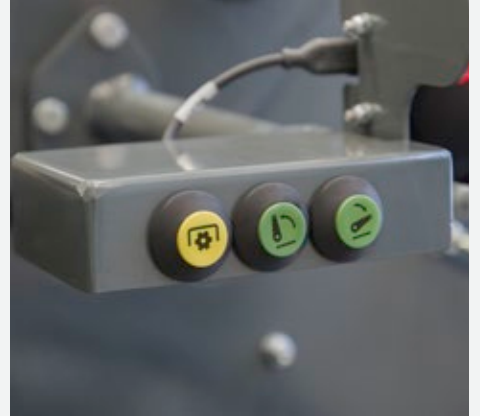

Powerful engines

Efficient fuel consumption

For maximum drive performance with minimum fuel consumption, the right engines are selected for all machines. You are also well-prepared for strict exhaust standards with the engines of the Kramer telehandlers. All engines comply with the current exhaust emission stage V.

The 1445 is powered by an 18.4 kW Yanmar engine without exhaust emissions after-treatment. For this model, a more powerful engine with 33.3 kW is optionally available. Here, the exhaust emissions are treated with DOC, DPF and SCR. A 45 kW Perkins engine is built into the 2205 and a 55.4 kW Kohler engine is built into the 2706. Here, the exhaust emissions are treated with DOC and DPF.

Top performance of the engines:

- high-torque and economical engines
- modern exhaust after-treatment with DOC + DPF
- newest engine technology for maximum performance

Overview of engines	1445 Standard	1445 Option	2205 Standard	2706 Standard
Engine manufacturer	Yanmar	Yanmar	Perkins	Kohler
Output [kW/hp]	18.4/25.0	33.3/45.0	45.0/61.2	55.4/75.0
Exhaust after-treatment system	-	DOC+DPF	DOC+DPF	DOC+DPF
Exhaust emissions stage (EU exhaust emissions standard)	Stage V	Stage V	Stage V	Stage V



Optimised running smoothness: Economical and powerful engines in all Kramer models.

Exhaust emission after-treatment systems

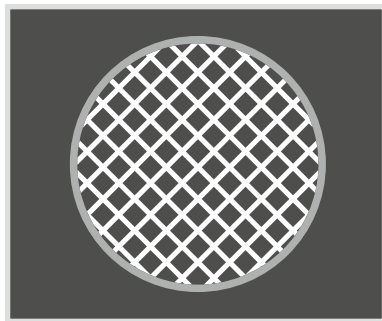

Diesel oxidation catalytic converter (DOC)

Catalytic converters are used these days to reduce emissions in many cars and lorries. The diesel oxidation catalytic converter has the same functionality. Without the movement of mechanical parts, it triggers chemical processes that reduce emissions.

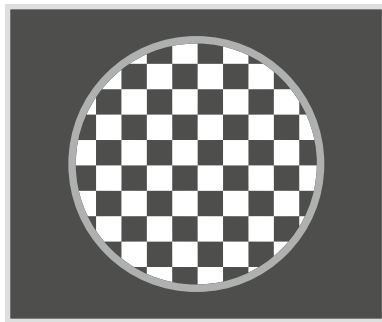

Diesel particulate filter (DPF)

The diesel particulate filter is used in conjunction with an oxidation catalytic converter to remove most of the nitrogen oxides, soot particles and non-combusted hydrocarbons from the combusted diesel fuel. The diesel particulate filter contains a porous honeycomb structure that catches the soot when it passes through. When the soot has accumulated to a certain extent, the machine's electronic system triggers fuel injections, which brings the non-combusted fuel into the oxidation catalytic converter, which is located before the filter. There is triggered an exothermic reaction that heats the exhaust fumes so much that the soot in the diesel particulate filter is combusted. This process is also known as regeneration.

Performance curve of Yanmar 3TNV82A-B; 18.5 kW; stage V (standard)

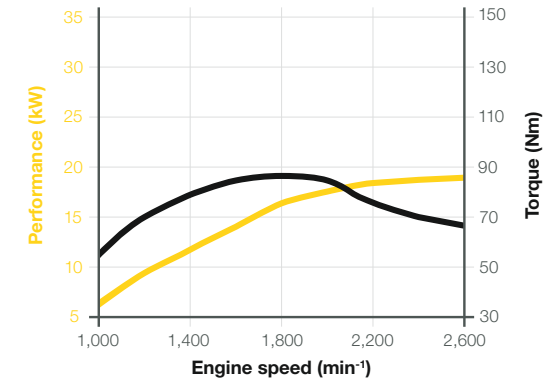

Performance curve of Yanmar 3TNV86CHT; 33.3 kW; stage V (option)

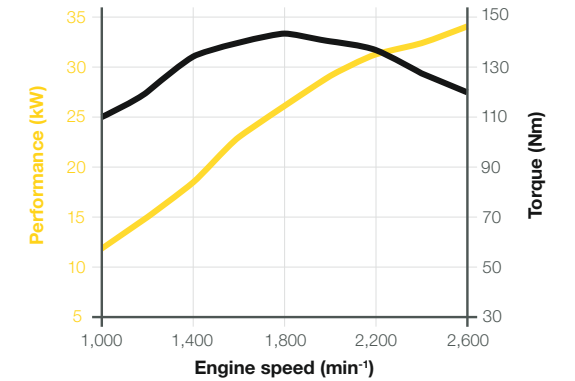

Performance curve of Perkins 404J-E22T; 45.0 kW; stage V (standard)

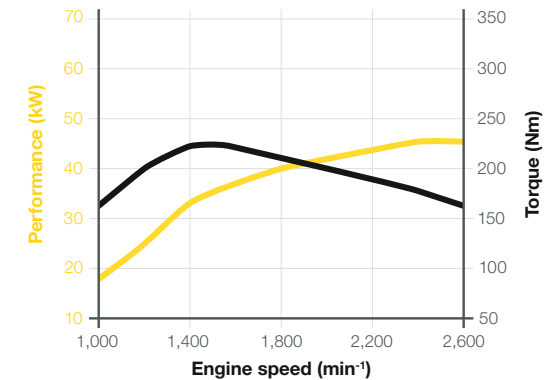

Performance curve of Kohler KDI 2504 TCR; 55.4 kW; stage V (standard)

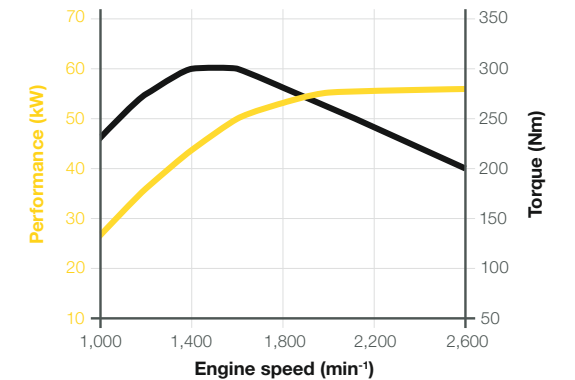

Everything under control inside Everything in view outside

The innovative cabin design ensures even more spaciousness in the cab, which has been designed according to the latest findings in safety technology and ergonomics. From the operator's seat through to the steering wheel, every detail is adjusted to the operator's needs.

The operator's central seat position and the cab's full glazing with deep-drawn panes in combination with narrow cabin pillars, ensure excellent all-round visibility of the entire work area all of the time. All of the operating elements are within reach and the most important machine information is always within the operator's view via the optimally positioned display. A working area that motivates and fully supports the operator.



Generous cabin with a wide-opening door for comfortable entry.

Technical Highlights Simple operation – Innovative cabin design

Switch concept



The respective functional group is very quick and easy to identify due to the colour-coded switches. Red = safety, green = hydraulics, blue = travel and grey = electrical system. This ensures the operator a convenient and safe operation without the risk of being confused. The result is increased working efficiency.

Steering column



The steering column and wheel can be adjusted according to the operator's requirements, both in terms of height and incline. The operator therefore also has more spatial freedom when entering and exiting. Furthermore, the steering wheel is made of a high-quality and non-slip material.

Armrest



The Kramer 1445's armrest is not only for additional comfort: Under the hinged armrest there is a practical storage area with a USB charging socket in which you could, for example, store a smartphone, while simultaneously charging it.

Control lever



It is possible to switch between the steering types using the instrument panel. Whether all-wheel, front axle or crab steering, there is an appropriate steering type for every application.

Continental radio



A continental radio with USB connection and Bluetooth hands-free system is available as an option. Even when working, you can have a good telephone connection via the Bluetooth hands-free system.

Other cabin features



The heating and ventilation system with fans and well-placed air nozzles ensures a comfortable working environment. We recommend using the optional air-conditioning system in particularly warm environments. Furthermore, the vehicle is equipped with an adjustable sun-blind for glare-free working.

Four driving modes

Even more flexibility in use

With the electronically controlled drive system and the accompanying four driving modes, machines can be optimally set to the respective working conditions.

Here, the auto mode ensures the usual 100% performance of the machine. In the eco mode, the rpm is reduced to 2,200 rpm for effective fuel-saving and noise reduction after achieving the desired travel speed. Furthermore, the travel speed can be finely tuned in the attachment mode. This guarantees a constant feed for the attachment. With the M-drive mode, the Y-load cycles can be optimally executed by determining the engine speed via the hand throttle and controlling the travel speed with the drive pedal. With this inching is superfluous.



1445



Top-performance telehandler 1445:

- very small turning radius due to compact design
- electronically controlled drive system with different operator modes
- perfect performance values of 18.5 kW (standard) or 33.3 kW (option)
- increased safety due to hill-hold function



Electric parking brake

The new electrical hand brake provides a hill-hold function. The brake automatically activates if the machine stands still, the direction of travels is set to neutral or the operator leaves the seat.

The electrical hand brake is automatically released if the machine is put into gear using the accelerator. Naturally, the brake can likewise be manually activated and deactivated by operating a switch. A real comfort and safety plus-point for the operator.



Two selectable speed levels

The speed levels can be easily changed while driving. The change is done conveniently via two touch controls on the joystick and is immediately shown on the display with the corresponding symbol (see below). In addition to the two freely selectable driving speeds, different driving modes can optionally be implemented:

Driving in auto mode, driving in eco mode, driving in attachment mode and driving in M-drive mode.

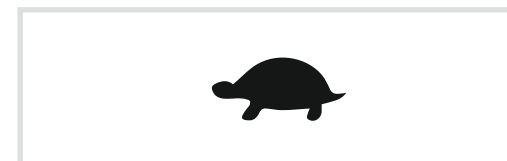

Turtle: 0 - 7 km/h

For work in which the speed needs to be finely controlled.



Hare: 0 - 20 (0 - 30) km/h

For long transport drives in which constant, swift speeds are an advantage.

Machine highlights at a glance

The compact genius among telehandlers



Compact dimensions
thanks to a vehicle width of below 1.60 m and a vehicle height of less than 2 m.

Innovative cabin design
with modern design and extended provision of space. The cab has been designed according to the latest findings in safety technology and ergonomics.

Electric parking brake
with hill-hold function for more comfort and safety.

LED work lights
provide the operator optimal visibility to the front and rear, as well as of the telescopic boom.

Driver assistance system - Smart Handling
enables smooth operation and supports work through a partially automated telescoping movement during demanding applications.

Powerful Yanmar engine (exhaust emission stage V)
with maximum power of 18.4 kW (25 hp) as standard and 33.3 kW (45 hp) with DOC + DPF as optional.

Three steering modes
with all-wheel, crab and front-wheel steering. Thanks to the all wheel steering, the machine is particularly manoeuvrable and stable.

Diverse tyre options
for the optimal tyres in every area of application.

Good working environment
thanks to a heating and ventilation system with fans, fresh-air filter and optional air-conditioning system.

Electronic drive system
for optimal coordination of the machine to the respective application.

Modern cab design

First-class comfort

Simple operation and functionality are the focus of this machine. The cabin design has been tailored to the operator's needs. As a result, the operator has plenty of room and everything is always in view because the large glass areas allow free visibility of the attachment at all times.

The all-in-one joystick provides secure and intuitive operation. In addition, the colour-coded switches provide an extra degree of clarity and user friendliness. With the suspended sensitive brake-inch and accelerator, the machine's movements are always extremely precise to control. The cabin comfort is completed with a flexible steering wheel and seat adjustment as well as their ergonomic design. Both contribute to a fatigue-free working over many hours.



Excellent all-round visibility: Narrow cabin struts provide an optimal view on all sides.

Technical Highlights

Simple operation – Innovative cabin design

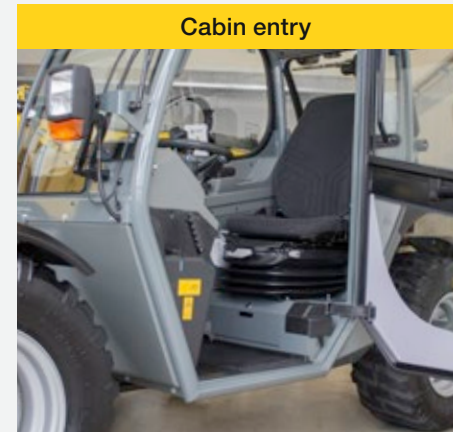

Through the low design and the low entry height attributable to this, you can comfortably enter or exit the cabin with just one step. Furthermore, there are two handles placed on the cabin to help the operator get to their workspace safely.

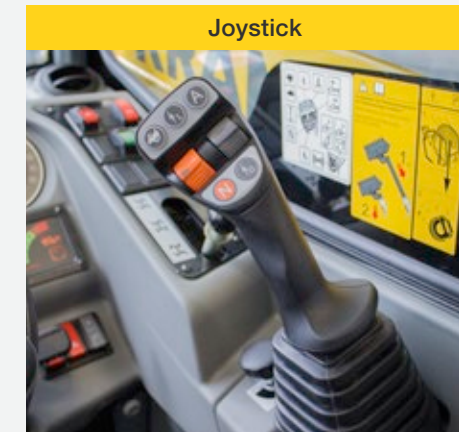

The intuitively usable multi-functional joystick is equipped with the most important operating elements. In the night design, the different touch buttons and wheels light up in different colours. The operator can then immediately identify the respective function and his vehicle is safely under control. It is possible to control the machine both sensitively and precisely at any time.

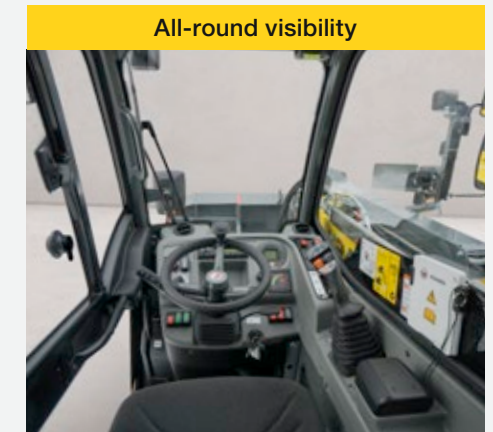

The central seat position in combination with the generous glass windows provide optimal 360° all-round visibility. The particularly clearly-arranged design of the 2205 and the seat position of the operator avoid "blind spots", even to the rear.



The incline-adjustable steering column can be adapted to the operator's needs. As a result, the operator can work with the machine ergonomically and fatigue-free. Furthermore, the steering wheel is made of a high-quality and non-slip material.

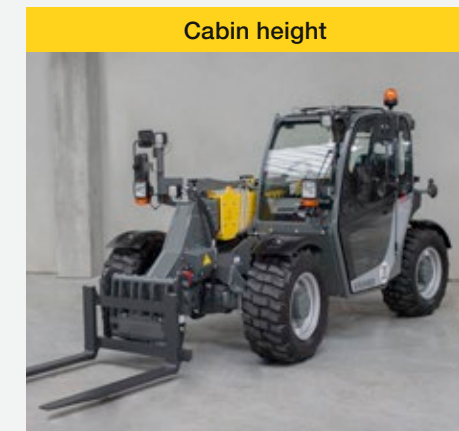

Due to the compact and low design, the total height of machine transportation remains below two metres. The compact dimensions with a width of just 1.81 m and a height of 1.95 m make the machine an irreplaceable accompaniment for working in confined spaces.

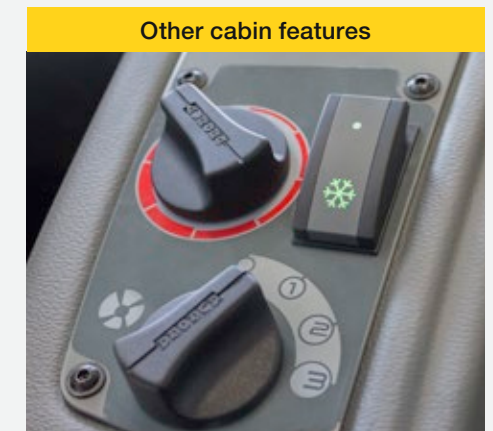

The optional air-conditioning system provides best-possible air distribution within the cabin. By filtering the interior air, cleanliness and well-being are improved. Furthermore, a high-quality continental radio with USB connection and Bluetooth hands-free system is available as an option.

Sturdy telescopic boom

Work easily with loads

The telescopic arm is designed to be sturdy and stable and is placed in the centre of the machine, which causes little distortion. The parallel guidance takes place hydraulically. The sliding components in the inner tube of the telescopic arm are maintenance-free. All-important hydraulic lines are ideally protected against external influences. With the compact 2205 incredible lift heights are reached and all of that with the best stability and compact dimensions.



Sturdy telescopic boom enables impressive lift heights and great reach ranges.

Top-performance telehandler 2205:

- compact dimensions with a height of under 2 m and a width of approx. 1.80 m
- spacious cabin with very good all-round visibility and a variety of options
- load stabiliser for improved driving comfort and driving safety
- high pushing power due to planetary axles and 100% connectible differential lock



Planetary axles

The drive via the planetary axles increases the torque on the wheel and thereby improves the thrusting force. Due to the optimal ratio between the pushing power and machine capacity, you work flexibly and economically at the same time. The planetary axle is rigid on the front and oscillating on the rear.

100% differential lock

If necessary, the up to 100% connectible differential lock offers you maximum traction, as well as pushing power and keeps the tyre wear low. Even wheel skids are prevented.

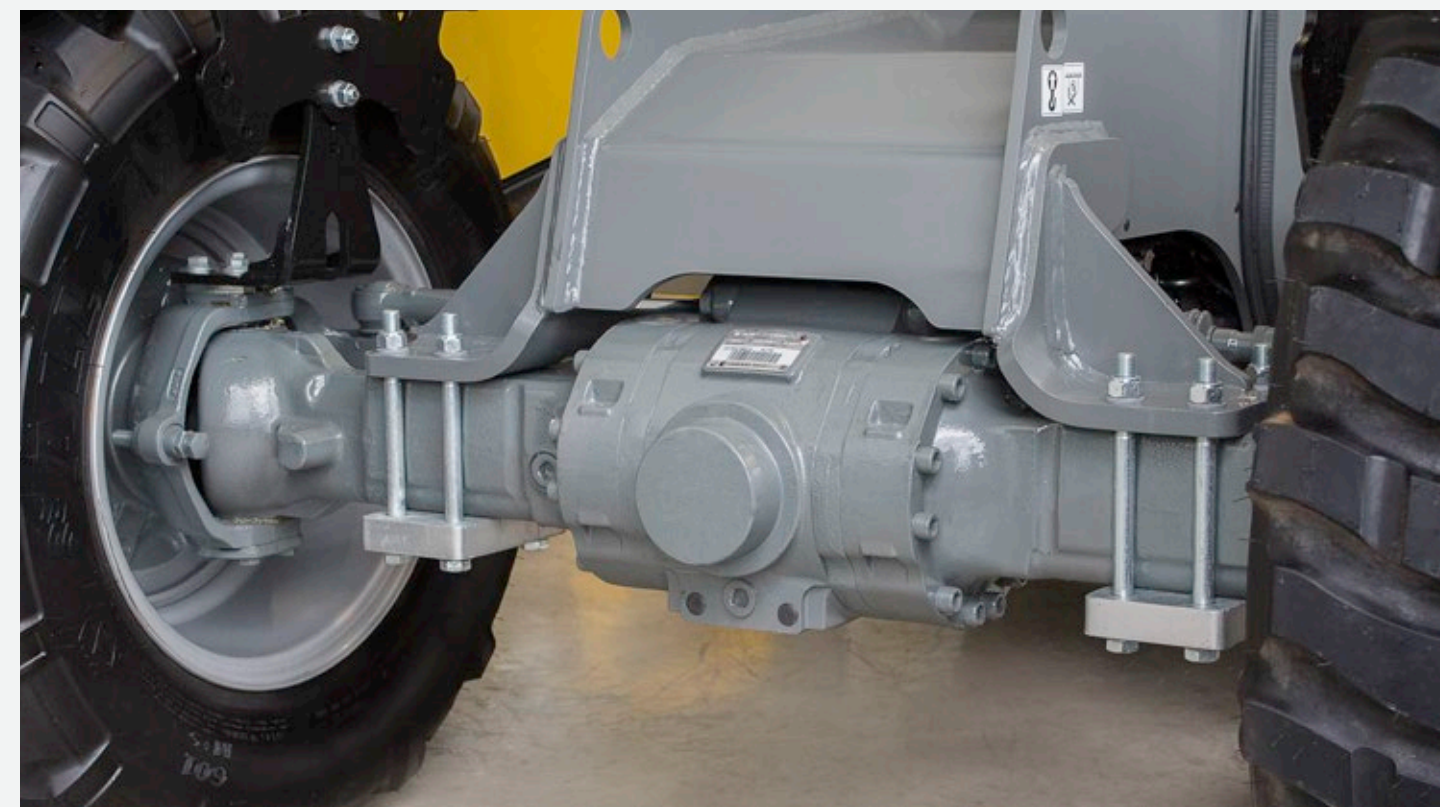

Machine highlights at a glance

Ideally equipped for use

Sturdy telescopic boom
for enormous lift heights with load stabiliser and end-position damping in all cylinders.

Massive quick change place
with four connection points for the perfect position of the attachment.

Compact dimensions
for easy working in tight spaces. Unique combination of lift height, width and machine capacity.

Driver assistance system - Smart Handling
supports work processes with partially automated telescopic movements and improves the stability of the machine.

Fatigue-free work
thanks to the spacious and ergonomic cabin.

Comfortable entry
due to low design and the low entry height attributed to this.

Diverse tyre options
for the optimal tyres in every area of application. A large selection of the most diverse tyres are available.

Simple maintenance
due to easy-to-open engine hood. The hydraulic oil tank, air filter, engine oil filling, oil-level dipstick and coolant are therefore quickly and easily accessible.

Several options for the rear
e.g.: rear hydraulics with power take-off.

Powerful engine
by Perkins with 45 kW / 61 hp (Stage V).

Comfortable working area

Thought out down to the last detail

The 2706's cabin design has been tailored to the operator's needs. Functionality, ergonomics and ride comfort were always the focus of the development. The large glass surfaces provide the operator an unobstructed view of the attachment at all times.

From the inside, the cabin impresses with its first-class space provision, outstanding all-round visibility and many other details, such as the deep-drawn and ergonomically shaped instrument panel, tilt-and-height adjustable steering column, storage or the radio with DAB+ and Bluetooth hands-free kit. Additional options, such as the optional air-conditioning system and air-sprung operator's seat, complete the provision.



Good visibility to the right due to the large dimension, right window and low position of the telescopic boom.

Technical Highlights

Simple operation – Innovative cabin design

Jog Dial



The optional Jog Dial primarily serves the individual oil volume adjustment of the different control circuits. Issuance is via the display instrument and is indicated as a percentage. In addition to this, other settings can be performed in the display instrument.

Low-speed control / hand throttle



With the low-speed control, incl. hand throttle, the machine's and attachment's optimal rpm can be set, as well as the correct working speed. Both values can be subsequently adapted to the work situation using the touch switches or sliders. This enables constant and simultaneously fatigue-free work applications.

Steering column



The steering column can be adapted to the operator's requirements in terms of incline and height. The steering wheel can be tilted back and forth by pressing the lever down. Pulling the lever effects the steering wheel adjustment in terms of height. Furthermore, the steering wheel is covered in a high-quality and non-slip material.

Joystick



The electronically controlled joystick enables extremely sensitive and precise work, as well as the integration of the driver assistance system, like Smart Handling, which supports the operator even more. In the innovative night design, the different touch buttons and wheels light up in colour.

Pedals



The suspended pedals with the combined brake-inch pedal allow for sensitive manoeuvring, even at a high rpm. Furthermore, the cabin floor can be easily removed and cleaned.

Other cabin features



A continental radio with DAB+ and Bluetooth hands-free system is available as an option. Furthermore, the optional air-conditioning system ensures a comfortable climate, even on warmer days. An optional rear view camera with a terminal screen supports all-round visibility and increases the operator's productivity.

Stacking at its best

Maximum flexibility in everyday work

The work hydraulics are supplied by powerful hydraulic pump, which ensures quick working cycles of the loader unit and enables the operation of special attachments via the 3rd control circuit, if necessary with continuous function. So that the machine is always in a safe position and the operator does not move the machine into the overload area accidentally, the 2706 is equipped with the second generation driver assistance system Smart Handling, as standard.



Top-performance telehandler 2706:

- improved all-round visibility due to two different cabin heights
- perfect performance values of 55.4 kW
- rpm reduction as standard
- LUDV-work hydraulics for the simultaneous execution of several hydraulic functions
- innovative cabin design for maximum comfort

Work hydraulics with load-independent flow distribution (LUDV)

ensure equal distribution of the hydraulic oil to the individual control circuits. Thus several functions can be simultaneously performed independent of the load, e.g. lifting and extending the telescopic boom.



Two cabin heights

The compact telehandler 2706 belongs to the 2x2 metre class, which means that the vehicle width and height are within the 2 m limit.

It is possible to freely select between two cabin heights. The low cabin with a height of 1.98 m ensures the vehicle's maximum compactness. The high cabin at 2.10 m provides even better all-round visibility and maximum comfort. The low cabin is accessed directly, the higher cab is accessed via a step.

Smart Loading

The bucket automatically returns to the pre-set position by pressing a button on the joystick after emptying. The desired bucket position is programmed using a touch button on the joystick. To do this, the target position of the tipping cylinder is set appropriate to the attachment, the joystick button is subsequently held for 3 seconds to store the position.

The position is approached from above or below independent of the angle position of the quick change plate. Electronic control ensures that the angle setting of the complete telescopic boom is stabilised. This means that at the press of a button, the attachment approaches the target position, independent of the position of the telescopic boom. The automatic return is independently applicable to the attachment.



Machine highlights at a glance

Refined, right down to the last nut and bolt

Higher efficiency
due to hydraulic quickhitch system
and robust telescopic boom.

Work hydraulics
with combined motion sequences
thanks to LUDV technology.

Driver assistance system - Smart Handling
Overload protection paired with higher
productivity enables a smooth working process.

Compact dimensions
due to vehicle width and height of less than
2 m. Suitable for application in confined spaces.

Two cabin heights (1.98 m / 2.10 m)
for maximum compactness or maximum comfort.

Comfortable cabin
with large-dimension, right window,
low position of the telescopic boom
and steep sloping engine hood for
best all-round visibility.

RPM reduction as standard
for the protection of the operator and the machine.

Numerous options in the rear
make the machine the perfect all-rounder:
among others, the three-point housing in rear,
depressurised return flow with overflow oil line, etc.

Diverse tyre options
for a broad range of
applications. A large selection
of different tyres is available.

Powerful engine
by Kohler as standard with 55.4 kW / 75 hp
with DOC + DPF (exhaust emission stage V).

Three steering types
support maximum manoeuvrability. And flexibility
(all-wheel, front-wheel and crab steering).

A variety of tasks

Always the right attachments

Regardless of what challenges your application holds for you: With the different attachments, you will always have a handle on the situation. Thanks to the hydraulic quickhitch system, you can adapt your Kramer wheel loader to any situation in no time. Standard attachments can even be changed in less than 10 seconds.

The attachment is based on your needs. You can find out more about our attachments at: www.kramer.de/attachments

Change in
record time!

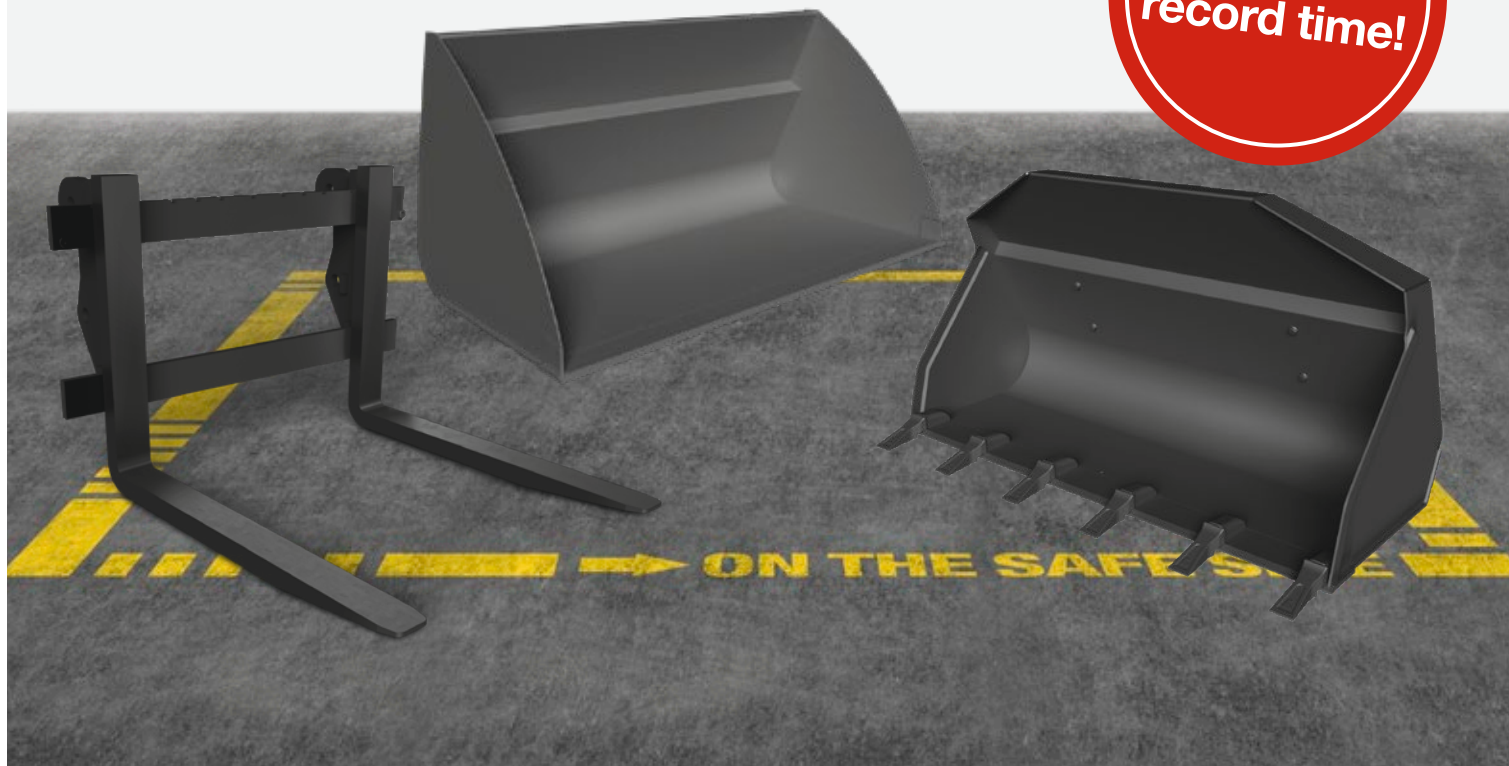

Product range of attachments



Pallet fork



Pallet forks
hydraulic parallel adjustment



Standard bucket with rip-out teeth

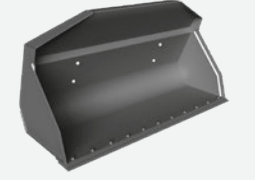

Standard bucket without rip-out teeth
with screwed-on blade

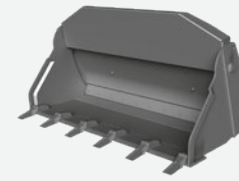

Power grab bucket with rip-out teeth



Power grab bucket without rip-out
teeth

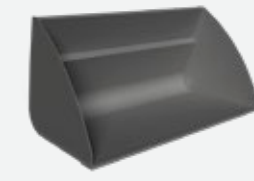

Bulk material bucket

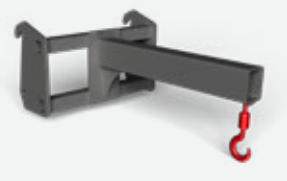

Jib crane

Exact specifications and availabilities of attachments vary by model and country. Your competent Kramer dealer will be happy to help you.

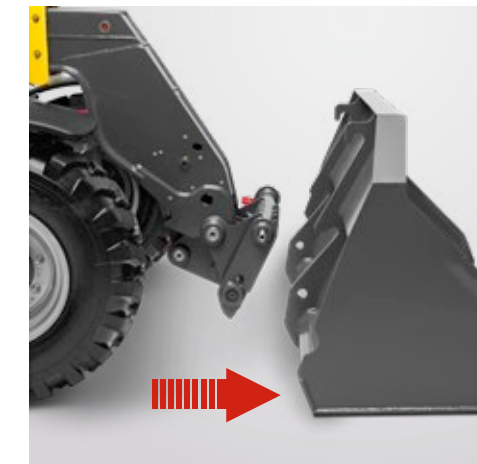

Hydraulic quick-change system (optional) - The Kramer quickhitch system: Approach the attachment, pick up the attachment hydraulically from the operator's seat and lock it using the touch slide on the joystick. The lock cylinder is located outside of the pivot point of the quick change plate and is thus not in the contamination area.

Tyre product range



- Good self-cleaning
- Large contact area
- Ground-protecting driving on sensitive subbases



- Good track guiding
- High level of driving safety
- Good self-cleaning
- High level of traction



- Good self-cleaning
- Good flank protection
- High running performance



- Good self-cleaning
- Good mobility on soft ground
- High level of traction

RP tread

AS tread

EM tread

MPT tread



- High level of traction
- Well-suited in sand and gravel
- Good resistance

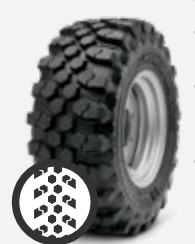

- High lift capacity
- High level of traction
- Excellent stability and improved operating comfort
- High level of running smoothness



- Good resistance
- Smooth running on the road
- High level of traction
- For applications on and off the road



- Good winter serviceability
- Noise-optimised
- For applications on and off the road

Multi-use tread

Bibload tread

Bibsteel tread

SureTrax tread

Choosing the right tyres is crucial when it comes to using your wheel loader. Exact tyre specifications and availabilities vary by model and country. Your competent Kramer dealer will be happy to help you.



EquipCare - Telematics

All the information at a glance

Always a step ahead, because EquipCare provides data, facts and answers to questions: Where is my machine right now, when is maintenance due and when does it make economic sense to replace wear parts? This helps you to avoid downtime and to extend the service life of your machine.

How does it work?

EquipCare is installed as standard on all Kramer vehicles. It contains a telematics module, which collects data from the machines and sends it to the manager or app via a cloud. Here, as the EquipCare user, you can view and assess the data.

The EquipCare Manager is the main portal for the telematics data of your vehicles and is controlled via the computer. The EquipCare app is for mobile access and keeps you informed about everything immediately, no matter where you are.

Your benefits:

Thanks to EquipCare, we always know where your machine is located currently. If the machine leaves a previously defined geo-zone, you will receive a notification on your smartphone or your computer. All events are shown here in detail, from the error message to the maintenance performed. All unnecessary downtime is avoided and the operating duration is precisely recorded.

The machine has recognised a problem? Notify you dealer of this on-site directly via the app and an initial remote diagnosis can be performed. Thanks to the proactive communication of your machine, you will be promptly informed about everything.

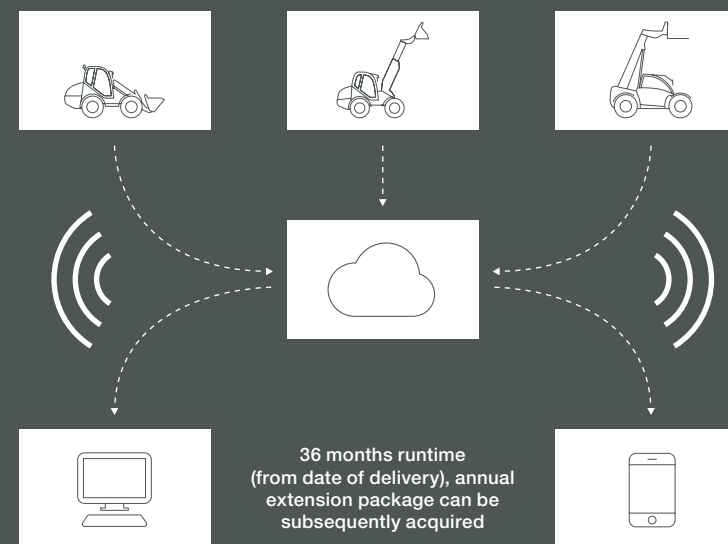

Warranty extension

We offer you the opportunity to extend your machine protection by 24, 36, 48 or 60 months. Get advice from your Kramer dealer.

You can find more information at: www.kramer.de/equipcare

SEARCH NOW!



EQUIPCARE

The telematics portals are available to you 24/7:



EquipCare Manager: The precise position or the GPS data of your machines can be viewed at any time in your password-protected area.

www.kramer.de/equipcarelogin

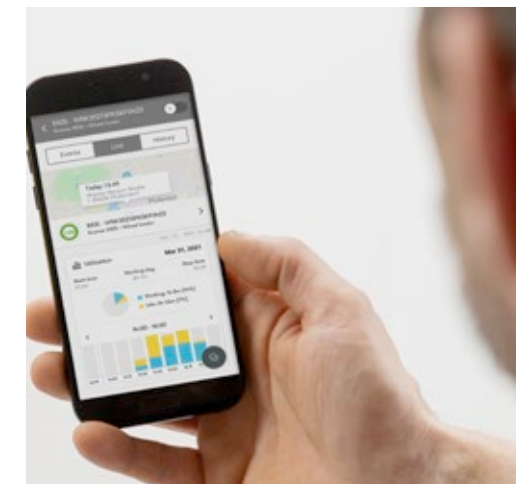

EquipCare App: The app provides you with a number of functions to access your machine data and information while on the go. Simply download and install the app from the Google Play Store or the Apple App Store.

◀ Go to the app

Top Performance

Dimensions and power to weight ratio

- perfect ratio between payload and operating weight
- unmatched economy and efficiency
- compact dimensions in the 2x2 metre class

Engines

- high-torque and economical engines
- the latest exhaust emissions after-treatment with DOC + DPF
- newest engine technology for maximum performance

Telehandler 1445

- very small turning radius due to compact design
- electronically controlled drive system with different operator modes
- perfect performance values of 18.5 kW (standard) or 33.3 kW (option)
- increased safety due to hill-hold function

Telehandler 2205

- compact dimensions with a height of under 2 m and a width of approx. 1.80 m
- spacious cabin with very good all-round visibility and a variety of options
- load stabiliser for improved driving comfort and driving safety
- high pushing power due to planetary axles and 100% connectible differential lock

Telehandler 2706

- improved all-round visibility due to two different cabin heights
 - perfect performance values of 55.4 kW
 - rpm reduction as standard
 - LUDV work hydraulics for simultaneous execution of several hydraulic functions
 - innovative cabin design for maximum comfort
-

Technical Data

Operating and power ratings		1445	2205	2706
Max. payload (LSP 500 mm)	kg	1,450	2,200	2,700
Max. stacking height	mm	4,301	5,165	5,730
Payload at max. stacking height	kg	1,450	1,700	1,800
Payload at max. coverage	kg	725	1,000	1,000
Stacking height at max. payload	mm	4,301	4,635	4,700
Reach at max. payload	mm	1,100	1,444	1,400
Max. reach	mm	2,289	2,660	3,156
Turning radius via tyres	mm	2,695	3,281	3,670
Operating weight*	kg	3,050 - 3,350	4,200 - 5,000	4,200 - 5,000
Engine		Unit		
Make	-	Yanmar	Perkins	Kohler
Type/Model	-	8TNV80FT (standard) 3TNV86CHT (option)	404J-E22T	KDI 2504 TCR
Output	kW/hp	18.4 / 25 (standard) 33.3 / 45 (option)	45.0 / 61.2	55.4 / 75
Max. torque	Nm	85 (standard) 142 (option)	222	300
Displacement	cm ³	1,267 (standard) 1,568 (option)	2,216	2,482
Exhaust emission stage	-	Stage V	Stage V	Stage V
Exhaust emissions after-treatment	-	- (standard) DOC + DPF (option)	DOC + DPF	DOC + DPF
Power transmission		Unit		
Drive	-	Hydrostat	Hydrostat	Hydrostat
Max. speed	km/h	20 (standard) 30 (option)	30 (option)	30 (option)
Total oscillating angle on the rear axle	°	14	20	20
Differential lock	-	100% in the front axle (option)	100% in the front axle (option)	100% in the front axle
Service brake	-	Foot-activated hydraulic disc brake	Foot-activated hydraulic disc brake	Foot-activated hydraulic disc brake
Parking brake	-	Electrically operated with hill-hold function	Hand-operated mechanical disc brake	Hand-operated mechanical disc brake
Standard tyres (AS tread)	l/min	255/75-15.3	10.5/80-18	340/80-18
Work hydraulics		Unit		
Work pump	-	Gear pump	Gear pump	Gear pump with LUDV
Max. flow rate (pump)	l/min	36.4 (standard) 42 (option)	70	89
Max. pressure	bar	220	225	260

Technical Data

Kinematics		1445	2205	2706
Bucket capacity	m ³	0.50 - 1.03	0.75 - 1.32	0.85 - 1.8
Total swing angle of tool carrier	°	148	144	132 (series) 150 (option)
Lift cylinder raising/lowering	s	7.8 / 5.3 (standard) 5.7 / 4.3 (option)	6.2 / 4.2	6.6 / 4.3
Extend/retract push-out cylinder	s	6.6 / 3.8 (standard) 4.6 / 2.7 (option)	5.1 / 2.5	5.5 / 3.5
Tilt out/in tipping cylinder	s	3.9 / 3.0 (standard) 2.7 / 2.0 (option)	3.3 / 2.5	2.9 / 2.8
Capacities		Unit		
Fuel tank	l	33	70	95
Hydraulic oil tank	l	36	55	80
Hydraulic system (total)	l	60	68	130
Noise emissions**		Unit		
Measured value	dB(A)	99.5 (standard) 101.2 (option)	103.4	103
Guaranteed value	dB(A)	101 (standard) 102 (option)	104	104
Noise level at the operator's ear	dB(A)	84 (standard) 85 (option)	77	80
Vibrations***		Unit		
Total vibration value of the upper body limbs	-	< 2.5 m/s ² (< 8.2 feet/s ²)		
Highest effective value of weighted acceleration for the body	-	< 0.5 m/s ² (< 1.64 feet/s ²)**** < 1.28 m/s ² (< 4.19 feet/s ²)*****		

* Standard weight with full tank + standard bucket + 75 kg operator weight as indicated in ISO 6016.

** Information: The measurement occurs as per the requirements of the standard EN 1459 and the directive 2000/14/EC. Measuring station: Paved surface.

*** Uncertainties of measurement as specified in ISO/TR 25398:2006. Please instruct or inform the operator of possible dangers caused by vibrations.

**** On flat and solid ground with the corresponding driving style

***** Application in extraction under harsh environmental conditions

Dimensions

Dimensions	Unit	1445	2205	2706
A Total length	mm	2,977	3,747	4,400
B Total length with bucket ¹	mm	3,944	4,576	5,000
C Total width without bucket ²	mm	1,564	1,808	1,960
D Track front/rear	mm	1,245	1,530	1,660
E Total height ³	mm	1,995	1,950 (standard) 2,150 (option)	1,980 (standard) 2,100 (option)
F Cabin width	mm	655	755	825
G Wheelbase, middle	mm	1,922	2,449	2,650
H Ground clearance ³ below axle and transmission, fording depth	mm	294	256	300
I Distance from centre of rear wheel to the tail	mm	427	472	730
K Tipping angle ¹	°	44	41	45 / 45
L Dumping angle ¹	°	31	34	22 / 40
M Load-over height ³ M1 retracted M2 extended	mm	2,949 4,163	3,638 5,056	3,730 5,600
N Dumping height ³ N1 retracted N2 extended	mm	2,352 3,566	3,103 4,520	3,450 5,280
O Dumping width extended	mm	476	293	680
S Distance from centre front wheel to blade leading edge	mm	1,595	1,655	1,030
T Distance from centre front wheel bearing to the quick coupler system seatings	mm	450	581	1,030
U Hinge pin height extended ³	mm	4,537	5,471	6,080
- Turning circle outer edge tyres	mm	2,695	3,281	3,670
- Turning radius bucket, outside edge	mm	3,550	4,153	4,500
- Entry height ³ cabin floor	mm	420	450	360

¹ with standard bucket

² depending on tyres, with mirrors folded in

³ Machine dimensions may vary depending on the tyres

Dimensions

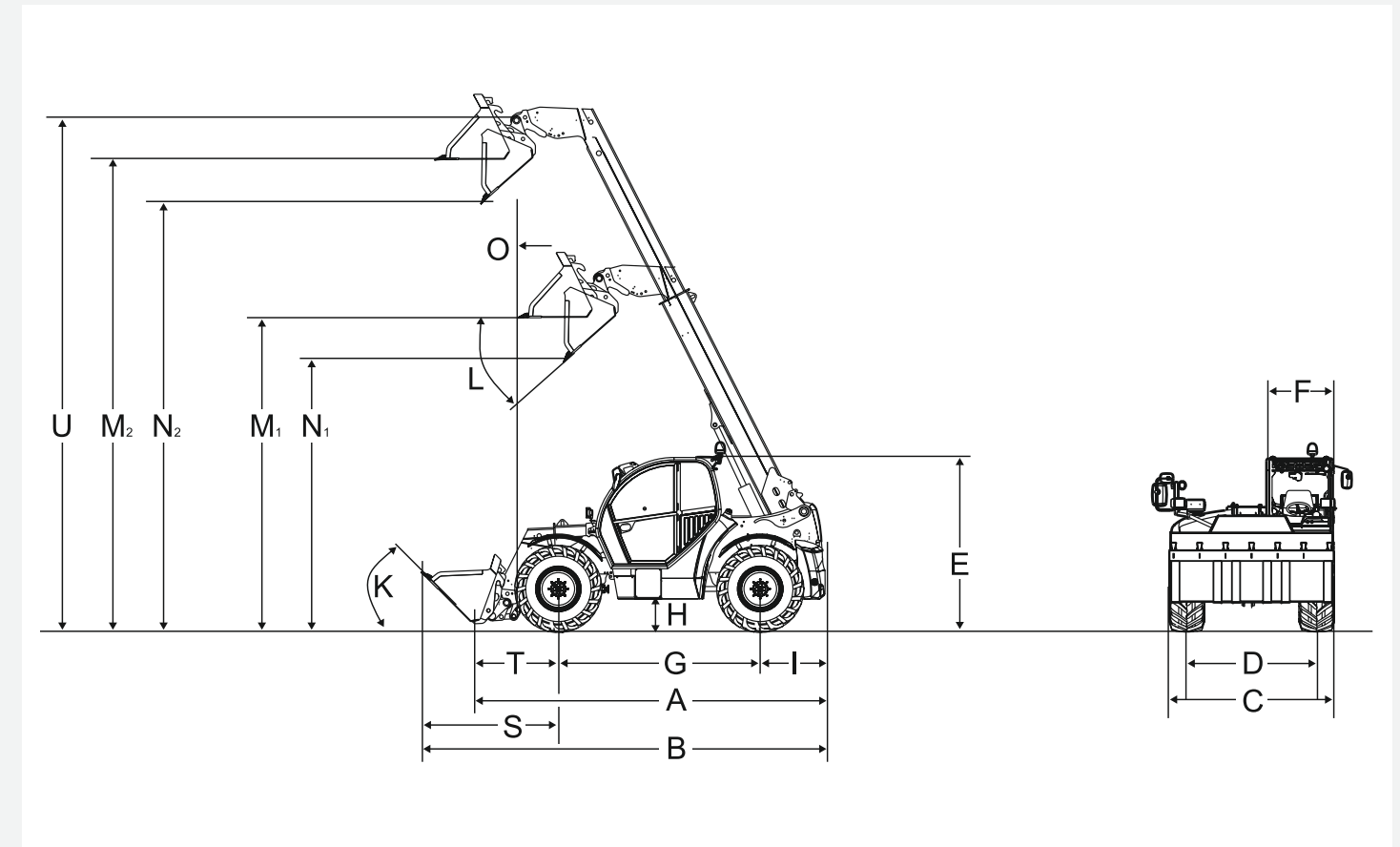

Load-bearing capacity diagrams

1445 Load-bearing capacity diagram (with LSP 500 mm)

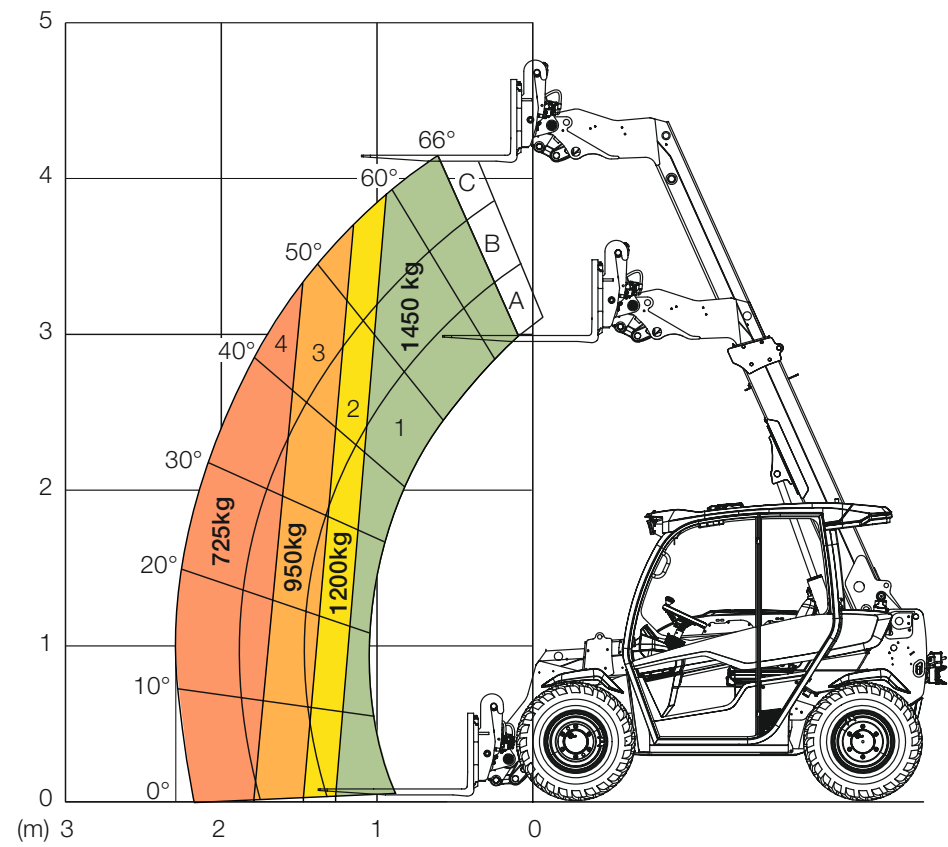

Load-bearing capacity diagrams

2205 Load-bearing capacity diagram (with LSP 500 mm)

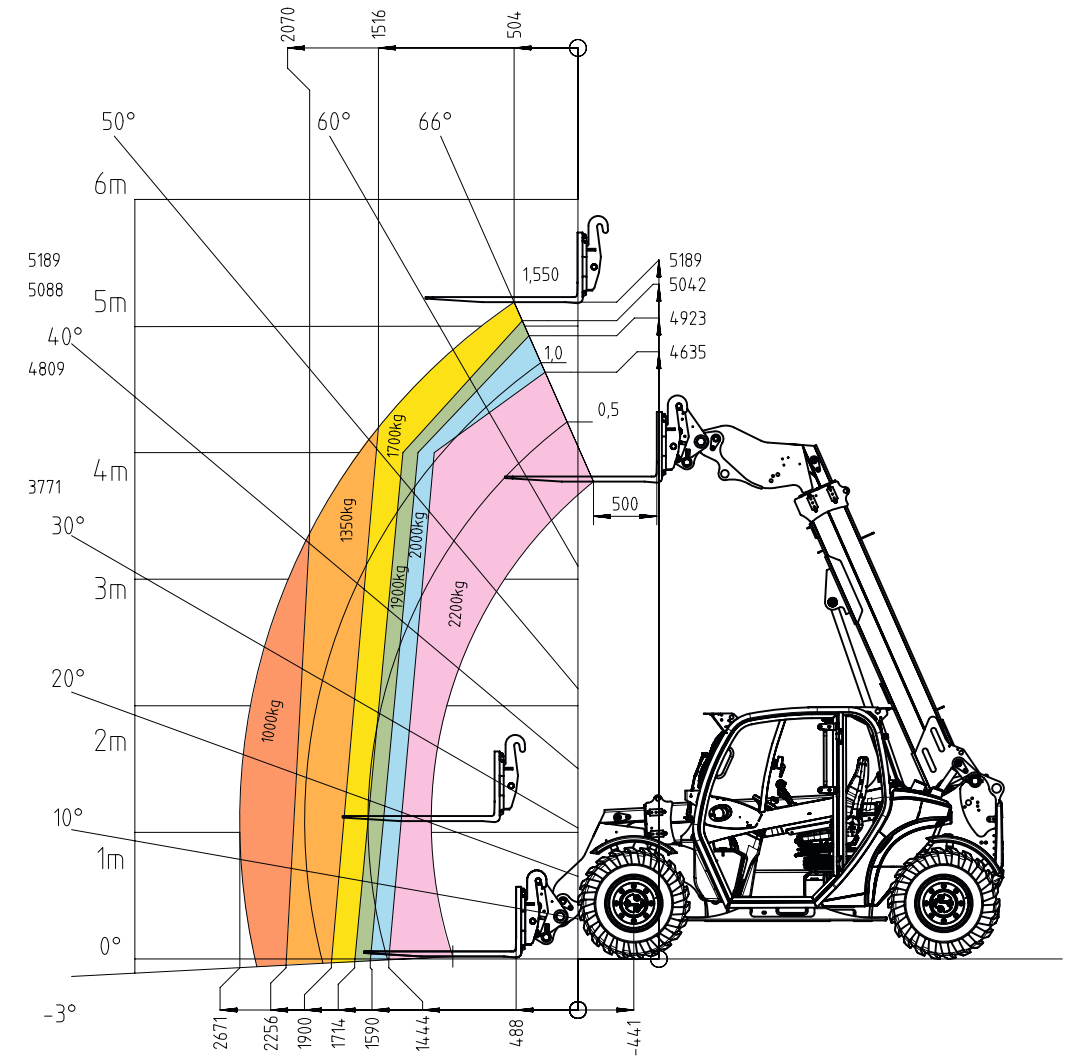

Load-bearing capacity diagrams

2706 Load-bearing capacity diagram (with LSP 500 mm)

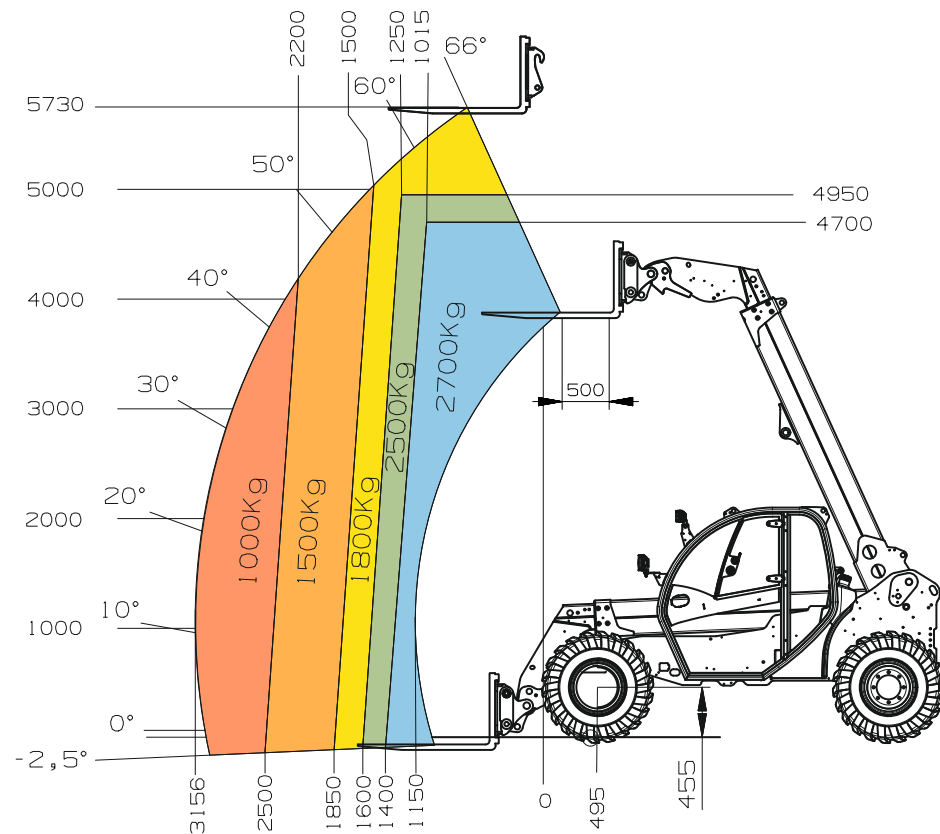

Service and spare parts

Are you looking for appropriate spare parts or operating instructions for your Kramer machine? With Kramer maintenance and repair packages, there is a tailor-made spare part ready at hand for each machine. You will receive all of the required spare parts or operating instruction from our Kramer dealers. With our Kramer Dealer Locator, you can find your local dealer. Simply enter the sector, post code or residence.

You can find more information at:
www.kramer.de/service

Maintenance, diagnosis and repair

The certified technician at your distributor will ensure that your machine is in use again as quickly as possible. You can find more information about the repair and servicing of Kramer machines on our website.



Original Spare Parts

All spare parts that you can source from your Kramer dealer meet the strict requirements of our component manufacturers. Dimensional accuracy, performance, fit and availability can largely only be provided by the original part.



Warranty and safety

Security 24 / Security 36 / Security 48 / Security 60: With the warranty extendible to 24, 36, 48 or even 60 months, our customers can increase their carefree period. They are protected against all eventualities by tailor-made insurance coverage. Get advice from your dealer.



Training sessions

The Kramer Academy is the modern training centre for the service technicians of the Kramer distributors. Here the mechanics learn everything they need to know to maintain Kramer machines and learn about the constantly about the operating principles of new technical systems.





Wheel loader
Bucket capacity: 0.35 - 1.80 m³



Telescopic wheel loaders
Bucket capacity: 0.65 - 1.45 m³



Telehandler
Payload: 1,450 - 5,500 kg

Service that can be seen

Focus on your daily activities – with our comprehensive services, we take care of the rest. We are there when you need us: capable, fast, and directly on site if necessary.



Repair & maintenance



Academy



Telematics



Insurance



Spare parts



Financial Solutions

Go to Kramer
dealer search:
SCAN HERE!



KC.EMEA.10030.V05.EN-GB