



YANMAR

C08-A

CARRIER



Operating weight

570 kg

Engine

LV 100 Stage V

Payload

800 kg

EFFICIENCY ON ALL TYPES OF TERRAIN



COMPACTNESS

Reduced total width and tight turning circle to fit through the narrowest of areas. Length of only 1 926 mm (without self-loader) and 2 595 mm (with self-loader) for easy transport.



ENGINE

Equipped with the LV generation of Yanmar diesel engines. Compliant with EU Stage V regulations. Durable and comfortable to use thanks to its powerful engine.



MAINTENANCE

Designed for simple maintenance to enable quick and easy access to all components and to facilitate daily checks.



SAFETY

Lockable parking break lever. Protected, ergonomic and functional dashboard. Dual filter protects the engine to allow for work in harsh conditions.



DUMPING

Large vessel capacity for such a compact machine. Forward tipping. High dumping angle of the vessel: one step dumping for safety.



ERGONOMY

Easy access to control levers and simple use. Access to operating position from either side. Very few vibrations transmitted to the operator. Integrated and protected document holder.

RELIABILITY AND ROBUSTNESS

- + 4 different versions for all types of applications : POWER, POWER+, HI TIP, HI TIP+
- + High performance for demolition, renovation, agriculture and landscaping.
- + Rubber crawlers do not damage the asphalt and offer an excellent adhesion on soft grounds.
- + Undercarriage equipped with track rollers with pendular supports to compensate for uneven ground conditions.



COMPACTNESS

- + The Yanmar C08-A is ideal for use on all types of ground and offers versatility and productivity.
- + The size of the C08-A allows it to work in extremely confined spaces, in which its width (810 mm for the standard version and 835 mm with self-loader) is a true asset.
- + It has an extremely solid track-mounted lower chassis and can climb steps or work on loose ground or in the snow.



DUMPING

- + Important vessel capacity :
 - 0,45 m³ heaped (POWER version)
 - 0,36 m³ heaped (POWER+, HI TIP, HI TIP+ versions)
- + The Hi Tip models have an unloading height of up to 1500 mm, and can tip their loads into most types of skip, passing over fences and garden walls and onto raised work areas.
- + The specific form of the oscillating rollers facilitates the passage of the machines over rough terrain, while keeping the load stable in the skip.
- + The C08-A payload is 800 kg, which allows it to work on a majority of jobs. It is designed for removing building materials and waste from worksites, and is equally suited to all kinds of material transport.

ERGONOMIC PILOT SYSTEM

The C08-A is accessible from both side and is very simple to use. It is quick and easy to start in all weather conditions and the precise and intuitive control levers improve the operator's comfort.

The C08-A offers convenient and precise travelling due to the hydrostatic transmission system and the vibrations felt by the operator are minimised.

These features reduce operator fatigue after a long, working day.



ENGINE

The Yanmar diesel Stage V engine and excellent hydrostatic transmission system with variable flow injection pumps installed in the C08-A minimise vibrations felt by the operator. This system provides the specific combination of speed and power that operators are looking for. The hydraulic systems controlling the skip and self-loader are kept separate, allowing them to be operated while travelling.



MAINTENANCE

Daily checks are facilitated through easy access to the maintenance points. The large engine hood opening, allowing optimum access to the main engine components and to the daily control points (water, engine oil, filters...) are positioned to facilitate the maintenance operations. Moreover, the dashboard is extremely user-friendly and intuitive. It offers the operator rapid familiarization and maximum safety on the worksite.



SAFETY

The C08-A has a protected, ergonomic and functional instrument panel equipped with hour meter, starter key and horn to maximise the operator safety on jobsites. It is also equipped with a lockable parking break lever and a dual filter system protecting the engine and allowing work in arduous conditions.

EQUIPMENT

VERSIONS

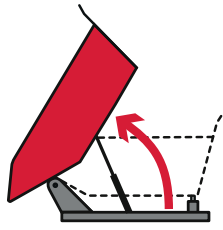

POWER

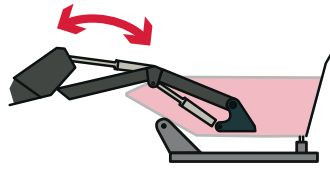

POWER+

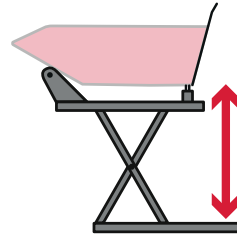

HI TIP



HI TIP+

STANDARD EQUIPMENT

Dual filter



1

Track rollers



2

Handbrake



3

Steel wheels

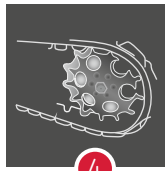

4

55 AMP/H

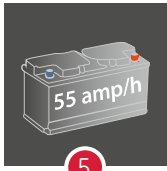

5

10 LT



6

Power button



7

Hour meter

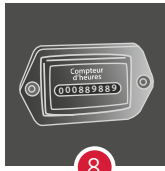

8

Pump with variable flow

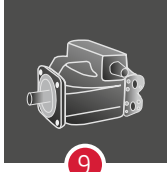

9

Big bonnet



10

Radiator with electric fan



11

Electric starter

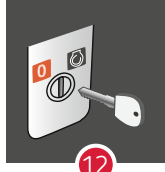

12

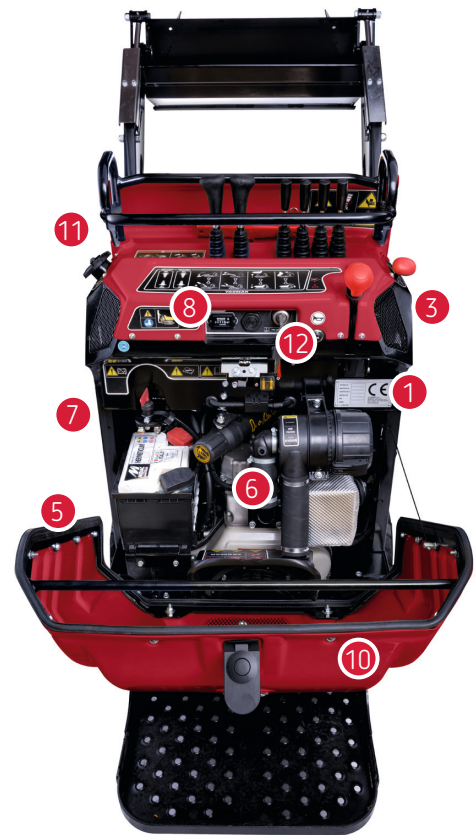

TECHNICAL SPECIFICATIONS

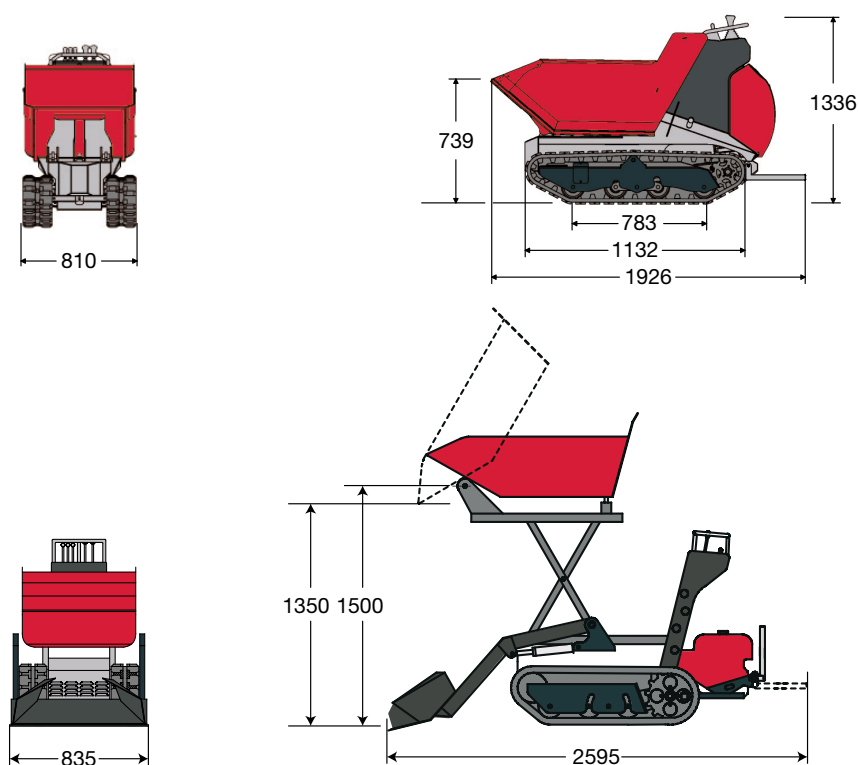

[WEIGHT]

	POWER	POWER+	HI TIP	HI TIP+
Operating weight	570 kg	660 kg	670 kg	765 kg

[ENGINE]

Type	LV 100
Fuel	Diesel
Net power	8.7 HP

[HYDRAULIC SYSTEM]

Transmission	Hydrostatic
Hydraulic pumps	2 pumps with variable flow for the translation 1 pump with fix flow for the equipment

[PERFORMANCE]

Max. travelling speed	4 km/h
Payload	800 kg
Dump vessel capacity SAE (POWER)	0,36 m ³
Dump vessel capacity SAE (POWER+)	0,34 m ³
Dump vessel capacity SAE (HI TIP)	0,36 m ³
Dump vessel capacity SAE (HI TIP+)	0,34 m ³

[UNDERCARRIAGE]

Track width	180 mm
Type	Track rollers



YANMAR



Yanmar Compact Equipment EMEA

GB_C08-A_0122



www.yanmar.com